

Reed level transmitter

For food applications

Model FLR-F

WIKA data sheet LM 20.06



for further approvals
see page 2

Applications

- Level detection for almost all liquid media
- Process water and drinking water treatment, food and beverage industry, pharmaceutical industry

Special features

- Process- and procedure-specific solutions possible
- Operating limits:
 - Operating temperature: $T = -80 \dots +200 \text{ °C}$ [$-112 \dots +392 \text{ °F}$]
 - Operating pressure: $P = \text{Vacuum to } 25 \text{ bar}$ [$362,6 \text{ psi}$]
 - Limit density: $\rho \geq 400 \text{ kg/m}^3$ [$25,0 \text{ lbs/ft}^3$]
- Wide variety of different electrical connections, process connections and materials
- Optionally with programmable and configurable head-mounted transmitter for 4 ... 20 mA field signals, HART®, PROFIBUS® PA and FOUNDATION™ Fieldbus
- Explosion-protected versions (option)

Description

The model FLR level transmitters with reed measuring chain are used for level measurement in liquid media. They work on the float principle with magnetic transmission.

The float's magnetic system in the guide tube actuates a resistance measuring chain that corresponds to a 3-wire potentiometer circuit. The measurement voltage generated by this is proportional to the fill level.

The measurement voltage is very finely stepped due to the contact separation of the measuring chain and is thus virtually continuous. Depending on the requirements several different contact separations are available.



Reed level transmitter, model FLR-F

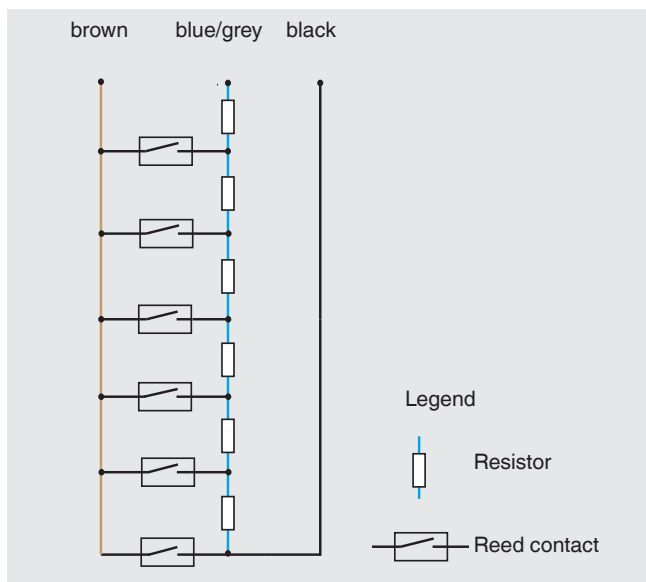

Internal circuit diagram of the reed level transmitters



Model overview

Level transmitter	Description
FLR-FA	Version without head-mounted transmitter
FLR-FB	Version with head-mounted transmitter

Approvals

Logo	Description	Country
 	<p>EU declaration of conformity</p> <ul style="list-style-type: none"> ■ EMC directive EN 61326 emission (group 1, class B) and immunity (industrial application) ■ RoHS directive ■ ATEX directive (option) Hazardous areas - Ex i II 1/2G Ex ia IIC T4 ... T6 Ga/Gb or No. KEMA 01 ATEX 1052 X II 2D Ex ib IIIC T80 °C Db - Ex d II 2G Ex d IIC T6 Gb / II 2 D Ex tb IIIC T80 °C Db No. TÜV 13 ATEX 7399 X 	European Union

The model FLR- F complies with the requirements of EC regulation no. 1935/2004.

Approvals and certificates, see website

Specifications

	Model FLR-FA	Model FLR-FB
Electrical connection	Connection housing: Aluminium 80 x 75 x 57 mm [3.1 x 3.0 x 2.2 in] without head-mounted transmitter Option: Polyester, stainless steel	Connection housing: Aluminium 80 x 75 x 57 mm [3.1 x 3.0 x 2.2 in] with head-mounted transmitter Option: Polyester, stainless steel
Material (process connection, guide tube, float)	<ul style="list-style-type: none"> ■ Stainless steel 1.4435 (316L) ■ Stainless steel 1.4404 (316L) Electropolished surface	
Process connection	<ul style="list-style-type: none"> ■ Threaded pipe connection DIN 11851, downwards, DN 50 ... DN 150 ■ Clamp pipe connection DIN 32676, DN 25 ... DN 100 or 1" ... 4" ■ Clamp pipe connection ISO 2852, DN 25 ... DN 150 Others on request	
Guide tube diameter	<ul style="list-style-type: none"> ■ 12 mm [0.5 in] ■ 14 mm [0.6 in] ■ 18 mm [0.7 in] 	
Max. guide tube length L	<ul style="list-style-type: none"> ■ 1,500 mm (guide tube diameter 12 mm [0.5 in]) ■ 3,500 mm (guide tube diameter 14 mm [0.6 in]) ■ 6,000 mm (guide tube diameter 18 mm [0.7 in]) 	
Float diameter	44 ... 120 mm [1.7 ... 4.7 in]	
Float selection	Depending on guide tube diameter and process conditions (see page 5)	
Max. operating pressure	See page 5	
Temperature range	-20 ... +120 °C [-4 ... +248 °F] Option: <ul style="list-style-type: none"> ■ High-temperature version: 120 ... 200 °C [248 ... 392 °F] ■ Low-temperature version: -80 ... -20 °C [-112 ... -4 °F] 	
Contact separation	<ul style="list-style-type: none"> ■ 5 mm [0.2 in] ■ 10 mm [0.4 in] ■ 15 mm [0.6 in] ■ 18 mm [0.7 in] 	
Resolution	<ul style="list-style-type: none"> ■ 2.7 mm [0.1 in] ■ 5.5 mm [0.2 in] ■ 7.5 mm [0.3 in] ■ 9 mm [0.4 in] ¹⁾ (depending on contact separation)	
Overall resistance of the measuring chain	Depending on length and separation	
Head-mounted transmitter	External transmitter	Head-mounted transmitter, see page 6
Tube end	<ul style="list-style-type: none"> ■ Float limitation welded to guide tube ■ Float limitation removable (with FDA conform sealing per CFR21 Food and Drugs for guide tube diameters 12 mm [0.5 in] and 14 mm [0.6 in]) 	
Output	3-wire potentiometer	4 ... 20 mA
Connection cable to transmitter/ control room	Cable length max. 2,000 m, 3-wire, shielded	2-wire, shielded
Permissible supply voltage	< AC 50 V < DC 75 V	See the data sheet of the head-mounted transmitter used
Mounting position	Vertical ±30°	
Ingress protection	Up to IP66 or IP68 per IEC/EN 60529 (depending on version)	

1) Not with high- and low-temperature version

Dimensions in mm

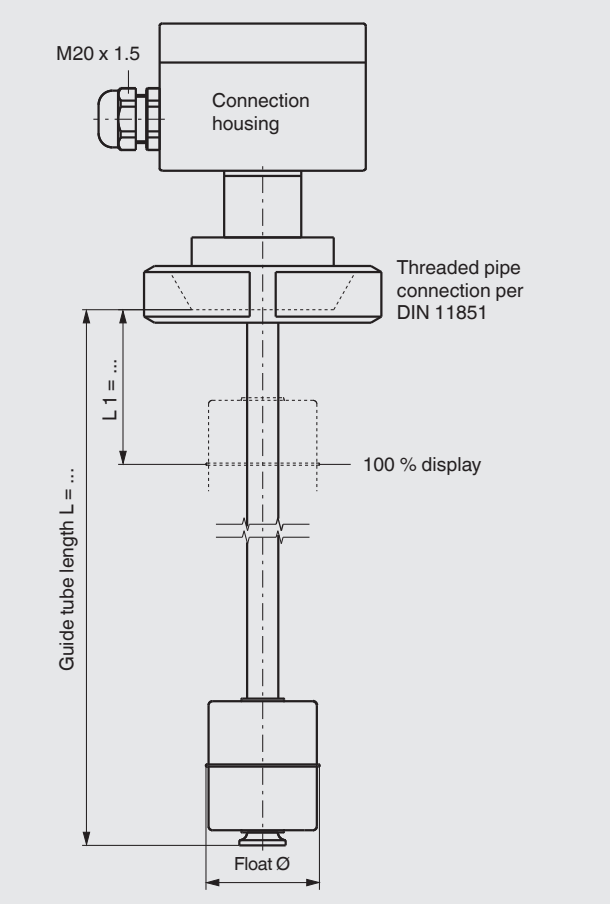

Threaded pipe connection per DIN 11854

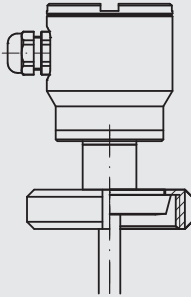

Clamp pipe connection per DIN 32676

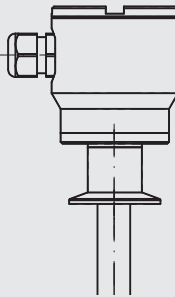

Float

Spherical float

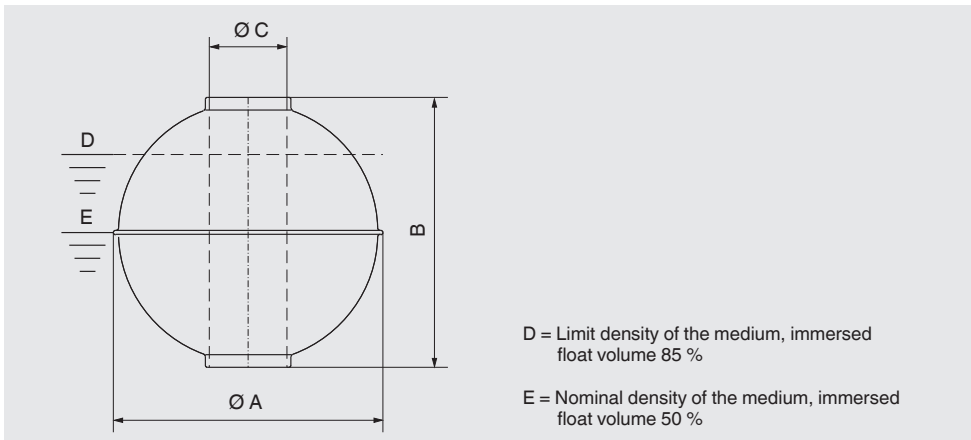

Material	Version	Suits guide tube Ø in mm [in]	Ø A in mm [in]	B in mm [in]	Ø C in mm [in]	Max. operating pressure in bar [psi]	Max. operating temp. in °C [°F]	Limit density 85 % in kg/m ³ [lbs/ft ³]
1.4404 or 1.4571	VE52R	■ 12 [0.5] ■ 14 [0.6]	52 [2.0]	52 [2.0]	15 [0.6]	25 [362.6]	250 [482]	700 [43.7]
	VE62R	■ 12 [0.5] ■ 14 [0.6]	62 [2.4]	61 [2.4]	15 [0.6]	16 [232.1]	250 [482]	597 [37.3]
	VE80R	18 [0.7]	80 [3.1]	76 [2.9]	23 [0.9]	16 [232.1]	250 [482]	617 [38.5]
	VE83R	■ 12 [0.5] ■ 14 [0.6]	83 [3.3]	81 [3.2]	15 [0.6]	16 [232.1]	250 [482]	412 [25.7]
	VE98R	18 [0.7]	98 [3.9]	96 [3.8]	23 [0.9]	16 [232.1]	250 [482]	561 [35.0]
	VE105R	18 [0.7]	105 [4.1]	103 [4.1]	23 [0.9]	16 [232.1]	250 [482]	520 [32.5]
	VE120R	18 [0.7]	120 [4.7]	117 [4.6]	23 [0.9]	16 [232.1]	250 [482]	394 [24.6]

Cylindrical float

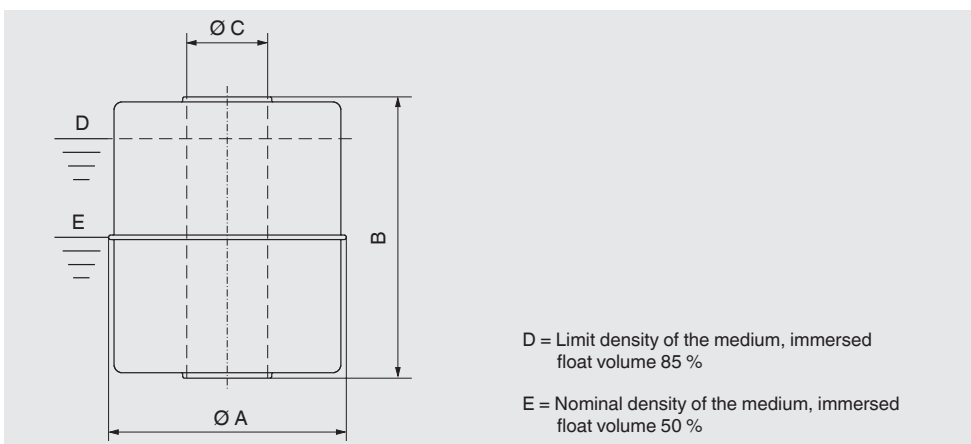

Material	Version	Suits guide tube Ø in mm [in]	Ø A in mm [in]	B in mm [in]	Ø C in mm [in]	Max. operating pressure in bar [psi]	Max. operating temp. in °C [°F]	Limit density 85 % in kg/m ³ [lbs/ft ³]
1.4404 or 1.4571	VE44R	■ 12 [0.5] ■ 14 [0.6]	44 [1.7]	52 [2.0]	15 [0.6]	16 [232.1]	250 [482]	740 [46.2]

Head-mounted transmitter

Model T15



Model T32



Model T53



Model	4 ... 20 mA	HART®	PROFIBUS® PA	FOUNDATION™ Fieldbus	Ex i	Order umber
TE	x	-	-	-	x	014832
TS	x	-	-	-	-	005894
T32E	x	x	-	-	x	025216
T32S	x	x	-	-	-	114795
T53F	-	-	-	x	x	025727
T53P	-	-	x	-	x	034422
T15	x	-	-	-	x	122955 122954

Ordering information

Model / Version / Electrical connection / Process connection / Guide tube diameter / Guide tube length (insertion length) L / Contact separation / 100 % mark L1 / Measuring range M (span 0 ... 100 %) / Process specifications (operating temperature and pressure, limit density) / Options

To order the described floats and head-mounted transmitters the order number is sufficient.

© 03/2020 WIKA Alexander Wiegand SE & Co. KG, all rights reserved.
The specifications given in this document represent the state of engineering at the time of publishing.
We reserve the right to make modifications to the specifications and materials.

